

Sys C/B '08 Dodge Ram 1500 5.7L Dual Side Exit

Warning: When working on, under, or around any vehicle exercise caution. Please allow the vehicle's exhaust system to cool before removal, as exhaust system temperatures may cause severe burns. If working without a lift, always consult vehicle manual for correct lifting specifications. Always wear safety glasses and ensure a safe work area. Serious injury or death could occur if safety measures are not followed.

Step 1: (Carefully read all instructions before installation) Disconnect the vehicle's battery before removal of the OEM exhaust. This will allow the computer to reset itself with the new system, and prevent electrical accidents. Begin removal of the OEM exhaust system by unbolting the clamp behind the mid-muffler. You can now disengage the welded hangers on the tailpipe from the rubber insulators and remove the tailpipe. Do not damage or discard the rubber insulators as they will be reused to mount the new system. Unbolt the mid-muffler and the front muffler and remove them in a similar fashion.

Step 2: Begin installation of the new exhaust system by installing the inlet pipe assembly using a supplied 3" clamp then insert the welded hanger into the OEM rubber insulator. Leave all clamps and fasteners loose for final adjustment of the complete system, see Diagrams 1 and 2 for more detail. Working rearward, install the new muffler assembly in a similar fashion using a supplied 3" clamp. You will need to install the threaded hanger and rubber insulator in a pre-existing hole in the frame to support the muffler assembly as shown.

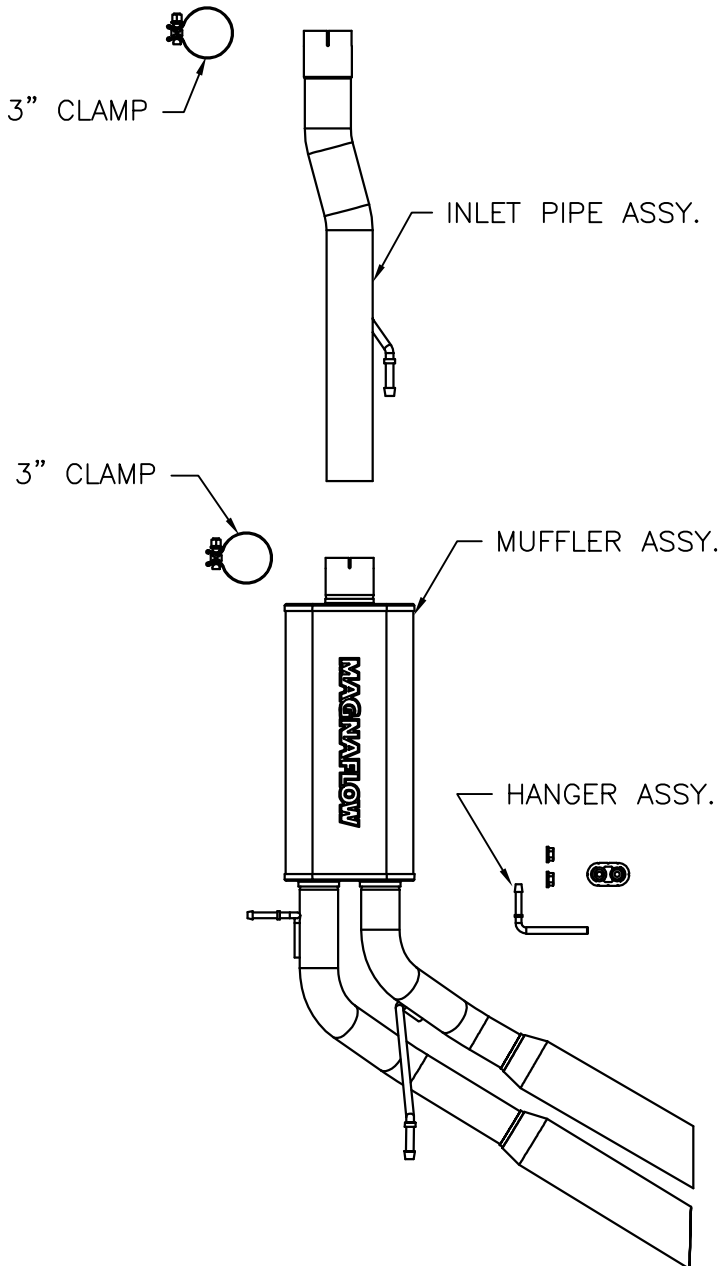

*MAGNAFLOW Performance Exhaust recommends professional installation on all their products

Technical support: 1-800-959-9226 ext. 4500

MAGNAFLOW Performance Exhaust - 22961 Arroyo Vista - Rancho Santa Margarita, CA 92688

Sys C/B 08 Dodge Ram 1500 5.7L Dual Side Exit



Step 3: With all components mounted loosely, adjust the system for overall aesthetics and clearance of frame & bodywork. (MAGNAFLOW recommends at least 1/2" of clearance between the exhaust system and any body panels to prevent heat-related body damage or fire.)

Step 4: Once a final position has been chosen for the new system, evenly tighten all fasteners from front to rear. The supplied band clamps must be VERY tight to properly align the pipes and prevent leaks (Approximately 65ft-lbs). U-bolt clamps should be tightened to approximately 30-35ft-lbs. Inspect all fasteners after 25-50 miles of operation and retighten if necessary.



**MAGNAFLOW Performance Exhaust recommends professional installation on all their products*

Technical support: 1-800-959-9226 ext. 4500

MAGNAFLOW Performance Exhaust - 22961 Arroyo Vista - Rancho Santa Margarita, CA 92688