

**2005-Current, Mustang High Output Nitrous System (Part #82242)**

Thank you for choosing ZEX™ products; we are proud to be your manufacturer of choice. Please read this instruction sheet carefully before beginning installation, and also take a moment to review the included limited warranty information.

Description	Qty.	Description	Qty.
Nitrous Solenoid	1	.074 N20/ Fuel Jet	1
Fuel Solenoid	1	.088 N20/ Fuel Jet	1
¼ NPT to -4 AN Filter Fitting	2	20 Amp Mini-Relay	1
-4 AN to 1/8 NPT Fitting	1	30 Amp Fuse Holder	1
24" -4AN Hose, 3 AN nut, 1/8 NPT end	2	30 Amp Fuse	1
3' Hose, -4AN, purple	1	Arming Switch	1
18' Hose, -4AN, purple	1	Aircraft Switch Cover	1
Solenoid Brackets	2	Electronic Throttle Activation TPS Switch	1
Nitrous Nozzle	1	Red 18 GA. Wire	15 ft.
1/8 NPT Bulkhead Fitting w/ Nut	1	Red 14 GA. Wire	15 ft.
Ford Fuel Rail Adapter	1	White 18 GA Wire	3 ft.
Fuel Adapter O-Ring	2	5/16-18 X 1" Bolt for Bottle Brackets	4
10lb. Nitrous Bottle w/Valve	1	5/16 - 18 Nut for Bottle Brackets	4
Bottle Bracket (short)	1	5/16 Flat Washer	4
Bottle Bracket (long)	1	M5 x 40mm Hex Head Bolt	2
.030 N20/Fuel Jet	1	M5 Washer	2
.036 N20/ Fuel Jet	1	#8 x ½, Sheet Metal Screw	6
.043 N20/ Fuel Jet	1	-4AN, 90 deg., Swivel Fitting	1
.052 N20/ Fuel Jet	1	1/8-27 NPT Tap	1
.064 N20/ Fuel Jet	1	TPS Resistor Wire	1

Why our nitrous system is better:

- A complete high-output, 2005-current, Mustang specific nitrous system. Everything is included in this kit for a safe, easy installation on the new generation Mustang.
- Adjustable from 100-250 horsepower; major power to win at the track.
- Uses a custom made Ford fuel rail adapter; a required component to access the fuel for the nitrous system.
- The Mustang GT Nitrous System is activated at wide open throttle with advanced electronics that monitor your throttle position sensor (TPS). Easy and safe activation, especially with the Mustang's new throttle-by-wire system.
- Unique nozzle design has "Active Fuel Control™" built in. This feature monitors bottle pressure and when the nitrous system is engaged, it adds or subtracts enrichment fuel so the engine never runs too rich or too lean.

Read This Pre-installation Guide Before Installing Kit !!!!!!!

How the ZEX™ Mustang High Output nitrous system works: The ZEX™ Part #82242 nitrous oxide injection system begins with a connection to a supply cylinder containing pressurized liquid nitrous oxide and a connection to the engine's fuel system. These connections go to the nitrous and fuel solenoids. These solenoids are normally closed, but are opened when the TPS activation switch senses that the nitrous system is armed and the engine is at wide-open throttle. Once these solenoids open, the nitrous and fuel are delivered to the nitrous nozzle via flexible delivery lines. The amount of nitrous and fuel that is injected through the nozzle is adjustable by means of metering jets installed in the nozzle itself. These metering jets allow for easy changes in horsepower settings.

Work safely. Always wear eye protection and gloves when working with lines or hoses that contain pressurized nitrous oxide or fuel. Never transport nitrous cylinders loose in a trunk or the back of a pick-up truck and especially NOT within a vehicle's interior whether the cylinder is full OR empty. Always disconnect the GROUND side of the battery when working on any electrical components.

Nitrous oxide won't fix problems you already have. Before you install your nitrous system, be sure your engine is in good mechanical condition. Intermittent wiring problems, etc., can lead to erratic system performance and possible engine damage.

Never defeat operation of the safety relief disc in the nitrous cylinder's valve. It's required by law and is there for your safety. Never drill, machine, weld, deform, scratch, drop, or modify a nitrous oxide tank in ANY way whatsoever!

Never overfill nitrous cylinders. That little bit extra will put you and others at risk of injury. More often than not, when the cylinder warms up, the pressure goes above the limit of the safety relief disc and you lose all the nitrous you just paid for.

All the power comes from the fuel, not the nitrous. Nitrous oxide is simply a tool that allows you to adjust how much and how quickly the engine burns the fuel. If the fuel isn't there, the power won't be either.

Avoid detonation at all times. Nitrous enhanced detonation is much more damaging than detonation that occurs when naturally-aspirated due to the increased amount of fuel available for releasing energy and the fact that more oxygen is present.

When system is activated, if something doesn't feel or sound right, BACK OFF. If you hear any detonation or feel anything unusual, get off the throttle. It's a lot easier to check everything over than it is to just try to drive through it and damage expensive parts. Don't activate or have the system activated when you hit the stock rev limiter. The stock rev limiter is a fuel cutoff. If you cut fuel while you're injecting nitrous, you're instantly very lean. This momentary lean condition has the potential of causing engine damage.

Spark plugs and nitrous performance: The factory spark plugs that come in the new Mustang GT are not suitable for use with any nitrous setting above 75 hp. The factory spark plugs are a particularly hot heat range and tend to overheat at higher horsepower levels. Attempting to use the factory plugs at higher horsepower levels can produce a detonation condition after a few seconds of nitrous use. The

**NITROUS
HELP™**
888.817.1008

ZEX™
3418 Democrat Rd.
Memphis, TN 38118
Phone: 1-888-817-1008 Fax: (901) 375-3430
www.zex.com

Part #ZEX196
Revised 9/18/07

solution to the problem is to install spark plugs that have a colder heat range and proper ground strap design for nitrous use. Consult your preferred spark plug manufacturer to ensure you install the correct spark plugs for the nitrous level you choose to run. Also, due to the cooler and denser inlet air charge that nitrous creates, it may be necessary to close-up your spark plug gaps to eliminate any misfiring. In our experience, .030 to .035 in. spark plug gaps typically will ensure proper ignition. You may be able to run a wider gap, or you may have to close them up, just be aware of this if you start to experience an ignition misfire when you are using your nitrous system.

Engine modifications: The ZEX™ nitrous system, out of the box, is designed to work as a bolt-on kit for stock or mildly modified vehicles. Mildly modified vehicles would include header upgrades, exhaust upgrades, air filter kits, etc. If major engine modifications have been performed, a fuel pump upgrade will be required for safe nitrous system operation. Major engine modifications would include turbochargers, superchargers, aftermarket cylinder heads, head porting, camshafts, intake manifolds, etc. Failure to upgrade the fuel system when using nitrous in these highly modified applications may cause serious lean conditions that can result in severe engine damage.

Do not use Teflon sealing tape on any fittings in a ZEX™ nitrous system. It is easy for Teflon tape to get pulled into the system, causing blockages that can ultimately lead to incorrect nitrous system performance and potentially, engine damage. Only use liquid thread sealer for all NPT type fittings. Do not use any thread sealing compound on AN style threads.

Do not attempt to start your engine if nitrous has been accidentally injected into the engine while it was not running. If this occurs, disable all eight of the ignition coils by unplugging the leads going to them. Push the accelerator pedal to wide open throttle and hold it there, push the clutch in, and with the throttle wide open, engage the starter and turn over the engine for several seconds to clear the nitrous from the engine. Failure to do this before attempting to restart the engine can lead to a dangerous intake system backfire.

Do not engage your nitrous system below 2500 rpm. This ensures that you will not have excessive cylinder pressures that could cause engine damage.

When finished using your nitrous system, close the nitrous bottle valve and relieve the line pressure. This eliminates the possibility that nitrous could inadvertently accumulate in the intake manifold while the nitrous system is not being used.

Do not run excessive bottle pressures. Excessive bottle pressures, over 1100 psi, are dangerous to your engine. Your ZEX™ nitrous system is calibrated and optimized to operate from 900-1000 psi. Exceeding this will not improve performance. Over 1100 psi also runs the danger of locking the nitrous solenoid closed due to excessive pressure working against the valve's plunger. If this happens, you must cool the nitrous bottle down to lower the pressure. This will allow the valve to operate properly again.

Start with the lowest horsepower setting and work your way up. This ensures if you have any tuning issues to work out on your vehicle, they will get sorted out with a smaller shot of nitrous that will be less likely to damage your engine. Once you have the car working well on the smaller shot, you can then safely start to step up your nitrous kit horsepower.

Make sure your vehicle has an adequate fuel supply. Nitrous systems put a large demand on your vehicle's fuel system. Make sure you have a large enough fuel pump to handle the demands of your engine, as well as the nitrous system.

How to adjust power levels: The ZEX™ 2005-current, Mustang High-Output Nitrous System is designed for multiple power levels. Metering jets installed in the nitrous nozzle control these power levels. To change the power output, all you need to do is install the appropriate set of jets. The correct combination of jets is listed on the tune-up sheet at the end of this instruction manual.

Engine computer modifications: Do not use any nitrous system if a non-nitrous custom tune has been programmed into your engine's computer. Custom computer tunes generally advance the ignition timing to optimize non-nitrous horsepower. If nitrous is injected while these non-nitrous tunes are loaded into your engine's computer, detonation will occur and this can lead to severe engine damage. It is important to only use computer tunes that have been specifically programmed for nitrous use. Specific tunes for nitrous should have the ignition timing reduced, per the tune-up chart at the end of this instruction manual. It is generally recommended that you retard the ignition timing around 2 degrees for every 50 hp worth of nitrous used, based on an optimized ignition curve for your engine.

Installation Instructions

- 1. Decide where to put everything.** Before you start to install the various components of this kit, you'll have to locate the best locations of each component by trial fitment and careful measurement. First, decide where you want to mount the nitrous and fuel solenoids. The area around the factory air box is ideal for this. If the vehicle is still utilizing the factory airbox, the flat side that faces the strut tower is ideal as a place to mount the NMU. Remember, the stainless steel braided lines that connect the solenoids to the nitrous nozzle are 24 inches long. Observe and mark the location on the air inlet tube where you would like to put the nitrous nozzle. The arming switch should be installed in a position convenient to the driver, but not in an area where it could be accidentally armed. Next, decide where and how you'll mount the nitrous supply bottle, check Fig. 1, 2, 3, and 4 for technical restrictions on bottle mounting locations and positions. In our experience, the passenger side of the trunk is an ideal location. Finally, have a reputable performance shop fill your nitrous bottle with automotive grade nitrous oxide before you begin. Do not overfill the nitrous bottle.

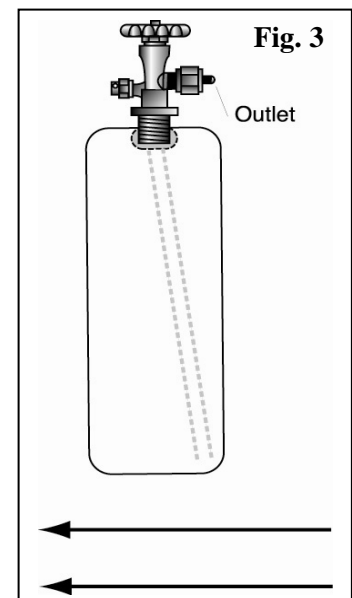
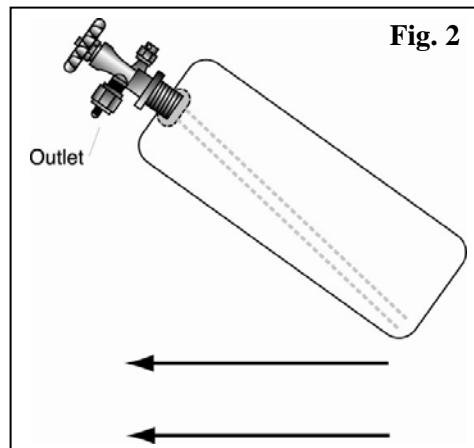
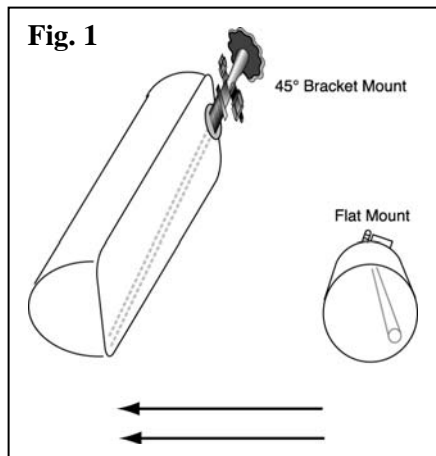

2. Mount nitrous supply bottle.

- A. Mount the nitrous supply bottle in the trunk of the vehicle with the outlet facing down. You may want to consider installing in a safety blow-down tube (ZEX™ Part #82099), as most racetracks require one. Route the tube from the safety pressure relief cap to the exterior of the car, preferably under the car. Doing so will prevent your car from filling with a cloud of nitrous oxide should the safety pressure relief cap rupture.
- B. Index the pickup tube with bottle position. (Refer to fig. 1, 2, and 3). ZEX™ nitrous bottles are designed with the bottom of the siphon tube at the bottom of the bottle towards the outlet. Always mount the bottle so that as your car accelerates, the liquid flows toward the pickup tube.

3. Mount nitrous delivery line under the car.

When routing the nitrous delivery line under the car, try to use the subframe as a conduit (Fig.4). This protects the line and eliminates the need to use clamps. The supplied cable ties work if you can run the line higher in the under-body so that it's safe from road level obstacles such as speed bumps. For the pro-race look, you can use steel loom clamps with rubber sheathing to fasten the line to the body. There are two rubber body plugs in the trunk of the Mustang, under the carpet, next to the rear shock towers. The plug that is located on the driver's side is an ideal location to route the nitrous delivery line through.

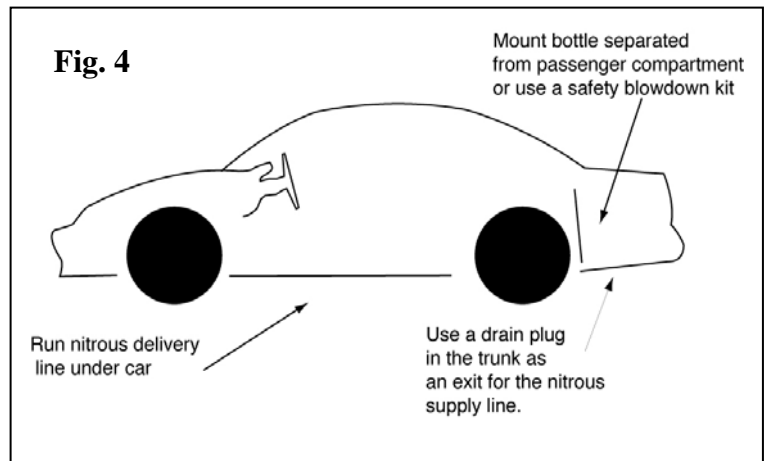

4. **Mount nitrous solenoids.** Assemble the -4AN filter fittings into the inlet side of both the nitrous and fuel solenoids. Install the 2 ft. long, -4AN hoses into the solenoid outlets. Make sure you use a liquid thread sealant on all NPT pipe threads. Attach the solenoid brackets to the solenoids using the pan head allen screws and find a suitable mounting location for them. Finally, attach the 16 ft. nitrous line to the inlet of the nitrous solenoid and attach the 3 ft. long, -4 AN fuel feed line to the inlet of the fuel solenoid.

5. **Install nitrous nozzle.** Optimum nozzle placement is 6" to 18" from the throttle body, between the mass air sensor and the throttle body. This range of distance gives the nitrous, fuel, and air, the proper time to mix before it enters the intake manifold plenum. After you have determined where to mount the nitrous nozzle in the intake, make sure this location won't interfere with other components. After you've found the spot, mark it and remove the air inlet duct

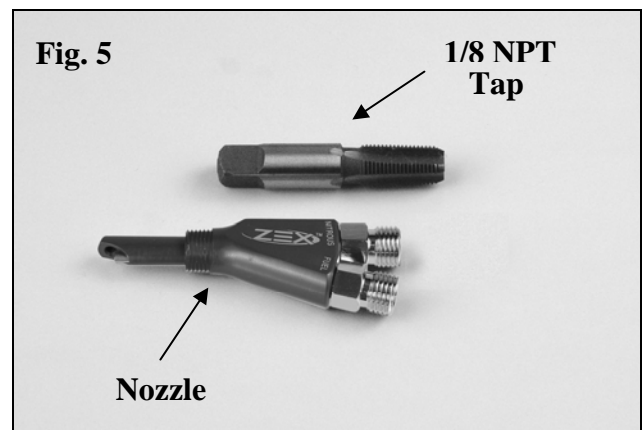

from your engine. Drill a 9/16 inch mounting hole and install the bulk head fitting. Be sure to remove any drill shavings since they can severely damage your engine. Install the nitrous nozzle so that the spray is in the direction of airflow. We've enclosed a tap (Fig. 5) should you need to mount the nozzle in a metal duct. Just drill a 11/32 inch hole where you want

to mount the nozzle, tap the hole and install the nozzle. Once the nozzle is installed, place the appropriate tuning jets in the nozzle and attach the 2-foot long, -4AN hoses to the nozzle jet fittings and the solenoids (Fig.6).

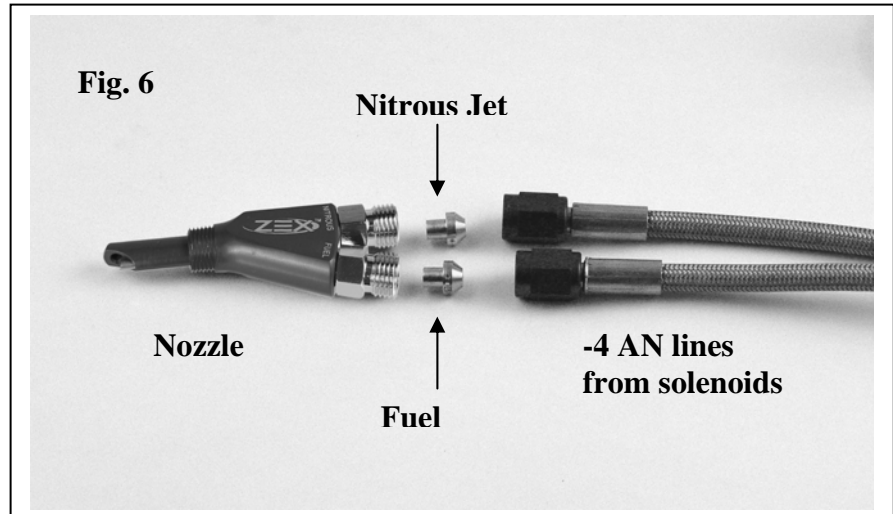

6. Wire it.

IMPORTANT TECH NOTE!

Due to the sensitivity of Ford's new throttle by wire system, the ZEX™ Electronic Throttle Activation Switch (ETAS) may cause intermittent check engine lights on some vehicles if the included TPS Resistor Wire is not used. It is required that you install the white TPS Resistor Wire between the engine's Throttle Position Sensor (TPS) output wire and the white TPS wire going to the ETAS. Use of this resistor will effectively isolate the Electronic Throttle Activation Switch and prevent check engine lights from occurring. This resistor in no way affects the activation or performance of your ZEX™ nitrous system.

A. Locate the four wires that go to the throttle position sensor. The wires are located on the passenger side of the engine's throttle body assembly. Using the supplied red T-tap connector, tap into the YELLOW wire. Attach the red crimp-on blade connector to one end of the white TPS Resistor Wire and plug it into the T-tap connector. Attach the other end of the TPS Resistor Wire to the white wire from the Electronic Throttle Activation Switch (ETAS). If the white wire from the ETAS is not long enough to reach the TPS Resistor Wire, an extra length of white wire has been included in the kit for your use.

B. Using the supplied electrical connectors and wire, refer to the wiring diagram for proper routing and electrical connections for the nitrous system (see Fig. 7). Always use the supplied fuse for electrical system protection in the event of a short in the system. The best positive (+) power source for the nitrous system's solenoids is a direct connection from relay post #5 to the battery's positive (+) post. Do not splice into the factory wire harness, it will not have the ability to supply the current required by the nitrous and fuel solenoids.

7. Program activation switch. Now that you have completed the wiring of your nitrous system, the next step is to program the activation switch. To program the activation switch, turn the

vehicle's ignition on, but do not start the engine. Turn the nitrous arming switch to the "ON" position. Go to the Electronic Throttle Activation Switch (ETAS) and locate the push-button. Depress, then release, the push-button switch. Observe the ETAS operation light. At this point, it should be RED. This RED light informs you that the ETAS is in learn mode. Return to the driver's seat and depress the accelerator pedal to the floor, holding it there for ten seconds. Release the accelerator pedal and go back to the ETAS and observe the operation light. At this point, the light should be flashing continuously from RED to GREEN to OFF. This is the ETAS's way of telling you that it has successfully learned the voltage curve of your engine's throttle position sensor. Go back to the driver's compartment and turn off the system's arming switch, then turn it back on. Go back to the ETAS and observe the operation light. It should be solid GREEN at this point. This informs you that the system is armed and ready to activate at wide-open throttle. Return to the driver's seat and depress and release the accelerator pedal several times. You should hear the solenoids click each time you reach wide-open throttle. At this point, your Electronic Throttle Activation Switch is fully programmed and ready for use. If you ever transfer your nitrous system to another vehicle, perform this same procedure on the new vehicle to "relearn" the ETAS.

8. Install fuel rail adapter and fuel delivery line.

WARNING!! The factory fuel system maintains fuel system pressure, even when the vehicle has been shut off.

- A. Locate the factory fuel pressure sensor that is bolted to the forward end of the driver's side fuel rail. Wrap a rag around the sensor and hold it down with your thumb. Remove the two bolts that hold the sensor to the fuel rail. SLOWLY start to remove the sensor, letting the fuel that is still under pressure, escape and soak into the rag. This will depressurize the fuel system.
- B. Take the Ford fuel rail adapter and lubricate the o-ring with WD-40, etc. Do the same for the fuel pressure sensor o-ring. Insert the fuel pressure sensor into the fuel rail adaptor and then insert the fuel rail adaptor into the fuel rail mounting pad. Take the two longer M5 bolts and washers that come in the kit and use them to tighten down the whole assembly. If any of the o-rings become damaged during the installation process, we have included an additional one in the kit for your use.
- C. Attach the 3 ft. -4AN fuel line to the fuel fitting on the Ford fuel rail adapter. It is important to use a backing wrench on the fuel fitting while tightening the hose assembly nut. The thin factory sheet metal fuel rail can easily be damaged if you attempt to tighten the hose without a backing wrench. Attach the other end of the fuel delivery hose to the nitrous management unit fuel inlet fitting.

9. Check fuel and nitrous pressure lines.

- A. Perform a final inspection of all plumbing and electrical connections to ensure that they are correct.
- B. Ensure that the nitrous bottle is turned off and the line pressure is relieved.
- C. Start the engine and observe all fuel connections for any leaks. Fix any fuel leaks before proceeding.
- D. Turn off the engine.

- E. Open the nitrous bottle valve. Listen carefully for any leaks as your valve is opened. Leaks in the nitrous supply line will be obvious because they will be covered in frost.
- F. If everything checks out, close the nitrous bottle and relieve the line pressure.

10. Check fuel quality & ignition timing. The last thing to do before enjoying your new nitrous system is to ensure that premium fuel (92 R/M Octane or better) is in the fuel tank and that your ignition timing is programmed correctly. It is recommended that any power settings above 150hp use high-octane racing fuel for maximum engine safety. All recommended ignition timing retard amounts, in the Tune-Up Specs, are calculated off of an optimized timing curve. If the correct ignition timing is not programmed into your engine's computer, severe engine damage may occur from detonation.

ZEX™ #82242 Nitrous System Tune-Up Specs

	100 hp	150 hp	200 hp	250 hp
Nitrous Jet (950 psi)	52	64	74	88
Fuel Jet (40 psi)	30	36	43	52
Ignition Retard (deg.)	4	6	8	10

Wiring Diagram

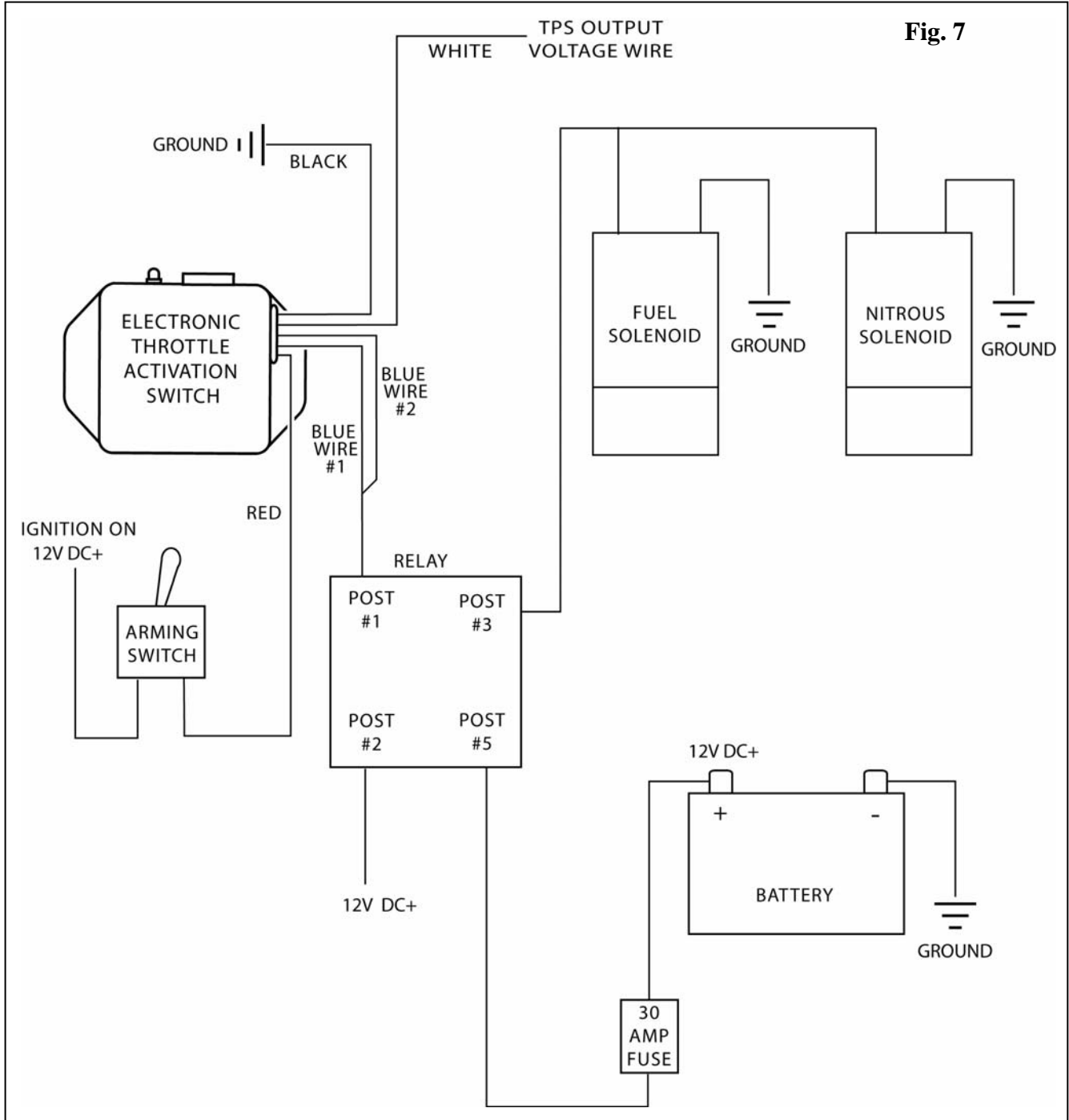

Limited Warranty

ZEX™ warrants that all of its products are free from defects in material and workmanship, and against excessive wear for a period of (1) one year from the date of purchase. This **limited warranty** shall cover the original purchaser.

ZEX's obligation under this warranty is limited to the repair or replacement of its product. To make a warranty claim, the part must be returned within (1) one year of purchase to the address listed below, freight prepaid. Items covered under warranty will be returned to you freight collect.

It is the responsibility of the installer to ensure that all of the components are correct before installation. We assume no liability for any errors made in tolerances, component selection, or installation.

There is absolutely no warranty on the following:

- A) Any parts used in racing applications;**
- B) Any product that has been physically altered, improperly installed or maintained;**
- C) Any product used in improper applications, abused, or not used in conjunction with the proper parts.**

There are no implied warranties of merchantability or fitness for a particular purpose. There are no warranties, which extend beyond the description of the face hereof. ZEX™ will not be responsible for incidental and consequential damages, property damage or personal injury damages to the extent permitted by law. Where required by law, implied warranties or merchantability and fitness are limited for a term of (1) one year from the date of original purchase.

This warranty gives you specific legal rights and you may also have other legal rights, which vary from state to state.